

WiFi + RF + Sensor Synchronous DIM 6 CH LED Control Box

Model No.: CV1(WT)

Features

- Dimming interface: WiFi, RF Wireless and Sensor
- Tuya APP cloud control, support brightness adjust, delay turn on/off light, timer run, scene edit function
- Voice control, support amazon ECHO and TmallGenie smart speaker
- Match with RF 2.4G single zone or multiple zone dimming remote control
- Match with a variety of induction sensor head
- 12-24VDC Input
- 6 channel synchronous constant voltage output, Max. total output power 60W
- Ultra-thin design, light weight and high efficiency
- Light on/off fade time 3s selectable
- Suitable for indoor LED lighting application
- 5 Year, 50,000hr warranty

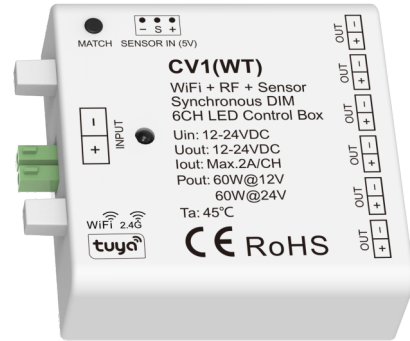

Applications

- Suitable for cabinet LED strip.

Mechanical Structures and Installations

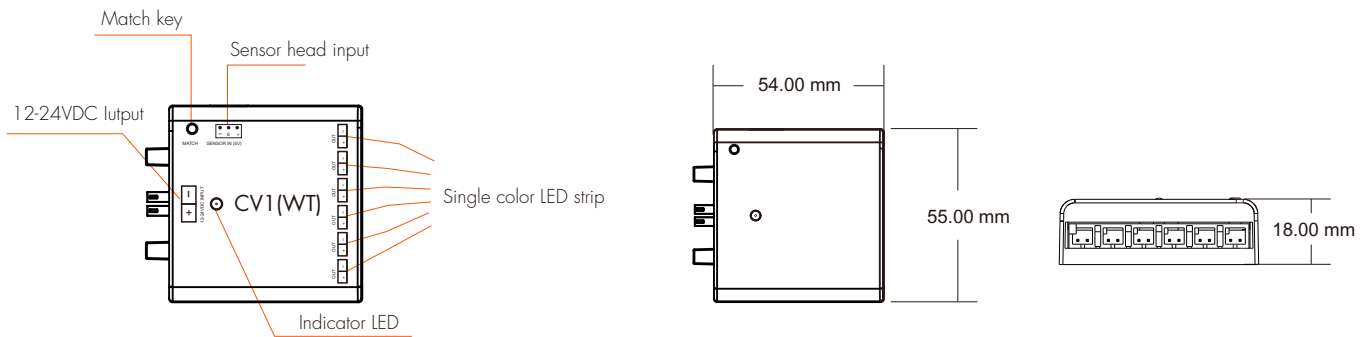

Wiring Diagram

1. Use alone, powered by constant voltage power supply

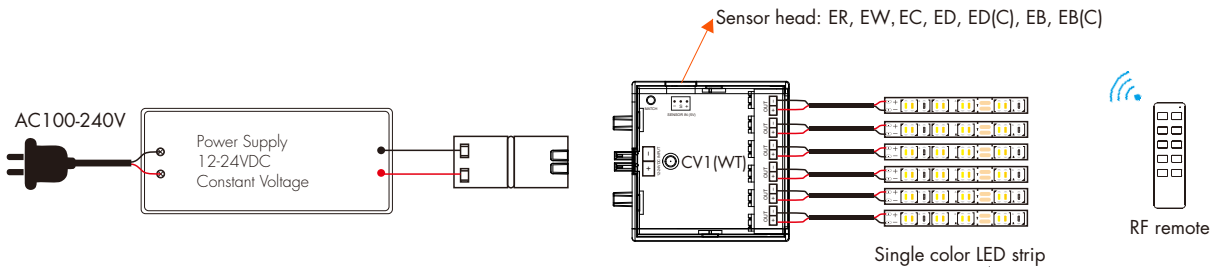

2. Matching cabinet LED driver use

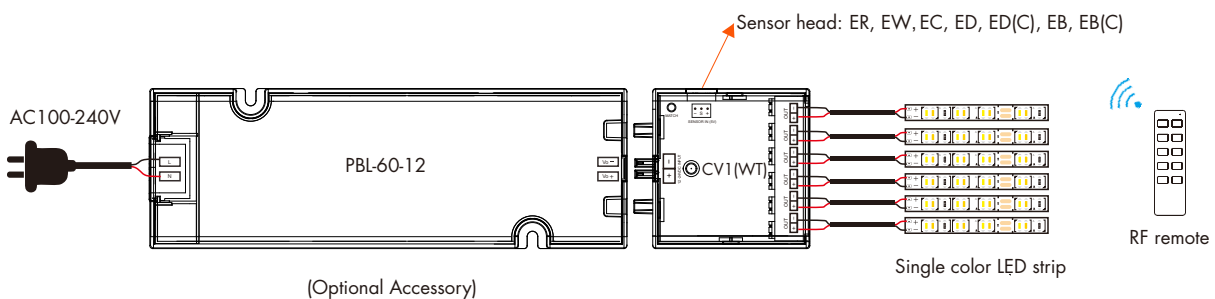

System wiring

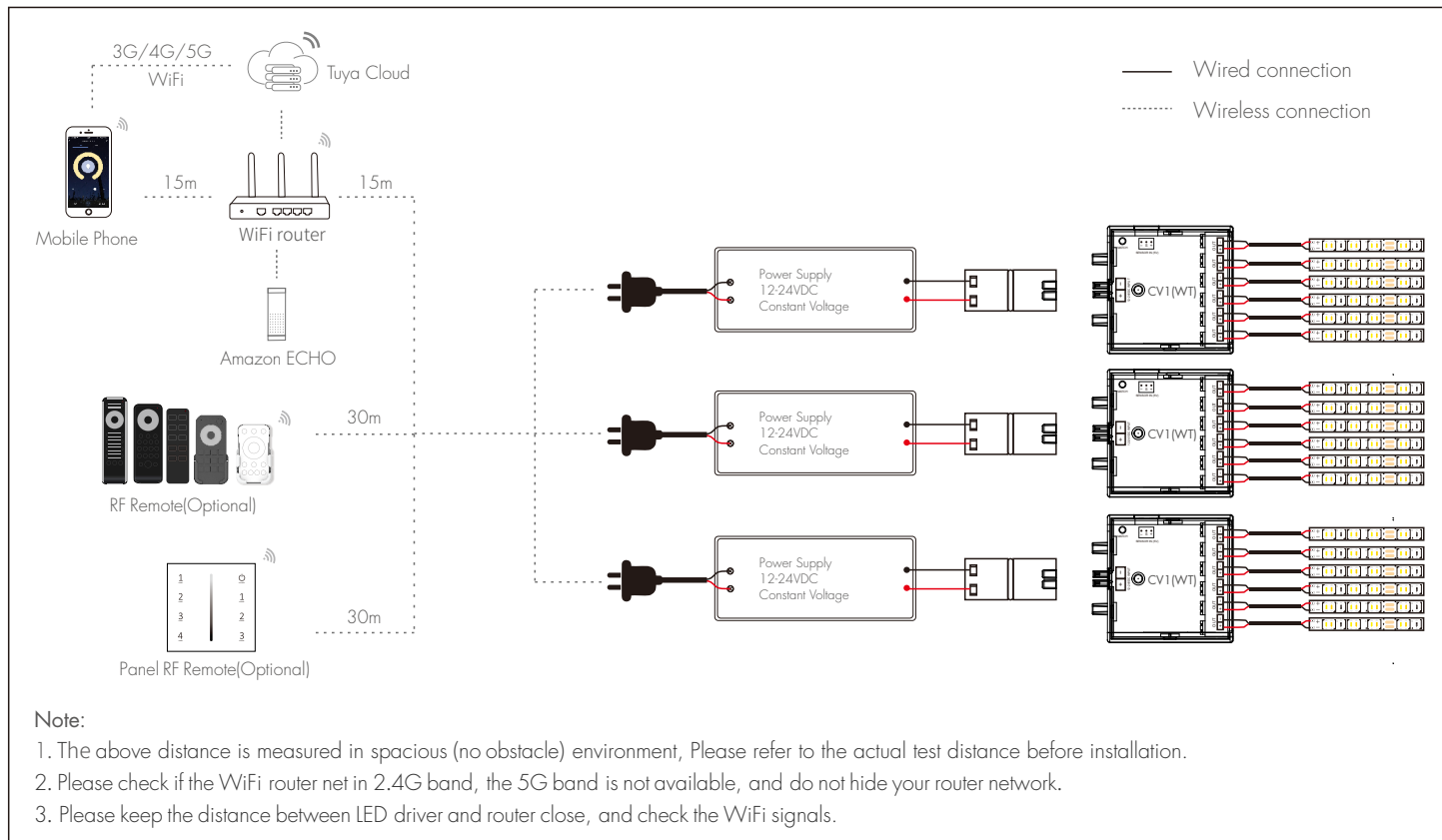

Match Remote Control

The control box can match with RF 2.4G dimming remote control optionally by default, except PIR motion sensor input.

For PIR motion sensor input, please long press the MATCH key 20s to disable the RF remote match function.

For other sensor input, please long press the Match key 10s to enable the RF remote match function.

The user can choose the suitable match/delete ways. Two options are offered for selection:

Use Match key

Match:

Short press match key, immediately press on/off key (single zone remote) or zone key (multiple zone remote) of the remote.

Delete:

Press and hold match key for 10s to delete all match, The light blinks 5 times means all matched remotes were deleted.

Use Power Restart

Match:

Switch off the power, then switch on power, repeat again. Immediately short press on/off key (single zone remote) or zone key (multiple zone remote) 3 times on the remote. The light blinks 3 times means match is successful.

Delete:

Switch off the power, then switch on power, repeat again. Immediately short press on/off key (single zone remote) or zone key (multiple zone remote) 5 times on the remote. The light blinks 5 times means all matched remotes were deleted.

Tuya APP network connection and operation

Press and hold Match key for 2s, or push twice Match key fastly, Clear previous network connection, enter Smart config mode, the blue LED indicator flash fastly.

Press and hold Match key for 5s: Clear previous network connection, enter AP config mode, the blue LED indicator flash slowly. If smart config failed, please try AP config.

Repeat power on and off for 5 consecutive times, also clear previous network connection, enter Smart config mode, the output LED will flash 10 times.







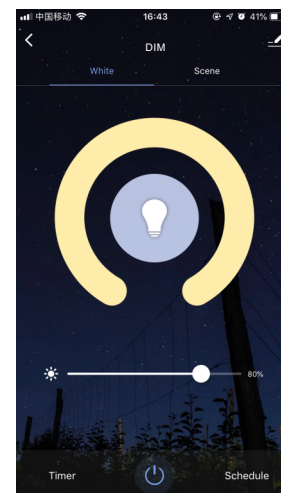

If Tuya APP network connection succeed, the blue LED indicator will stop flash, and in Tuya APP, you can find DIM device.

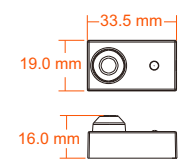
Tuya APP interface operation:

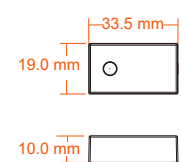
Touch brightness slide to adjust brightness.

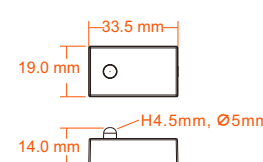

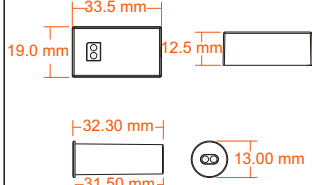
Available sensor head

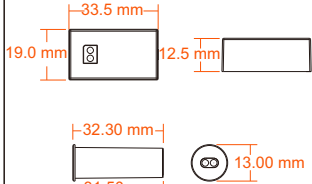
Model and Product name	Features	Product picture	Size	Sensor data
ER PIR Motion Sensor	When people or objects enter the sensitive field, the light turn on; when these exit the sensitive field, the light turn off after 30 seconds.			Sensitive field: $\leq 3m$ Sensitivity angle: 120
EW Wood Touch Sensor	The medium can be wood, glass or plastic. Short touch the sensing area to turn on or turn off light; long touch the sensing area to dimming up or down.			Dimming range: 0-100% PWM Frequency: 2KHz Detective distance: $\leq 5cm$
EC Touch Sensor	Short touch the LED to turn on or turn off light; long touch the LED to dimming up or down.			Dimming range: 0-100% PWM Frequency: 128Hz
ED ED(C) Door Sensor	When the door open, or no obstacle ahead, the light turn on gradually; when the door close, or obstacle ahead, the light turn off gradually.			Detective distance: $\leq 10cm$ Detective angle: 15-30
EB EB(C) Hand Sweep Sensor	When hand sweep, the light turn on gradually; when hand sweep again, the light turn off gradually.			Detective distance: $\leq 8cm$ Detective angle: 15-30

Sensor wire define

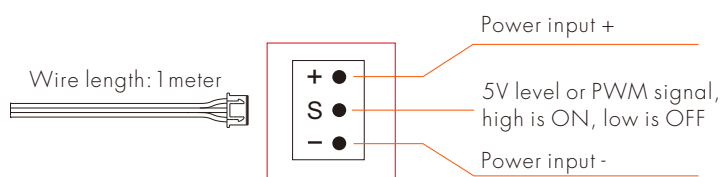

Light on/off fade time

Long press match key 5s, then short press match key 3 times, the light on/off time will be set to 3s, the indicator light blink 3 times.

Long press match key 10s, restore factory default parameter, the light on/off time also restore to 0.5s.

Installation precautions

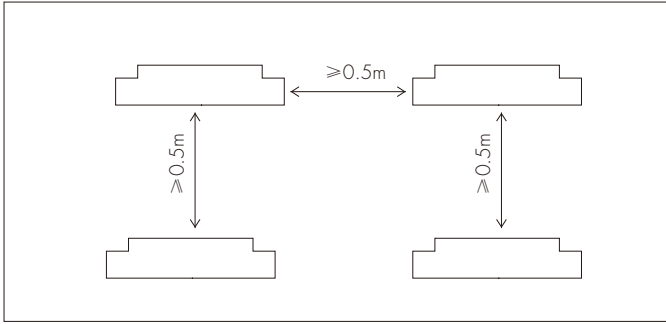

Please do not stack the products.

The distance between two products should be $\geq 0.5\text{m}$, so as not to affect heat dissipation and lifespan of the products.

Dimming Curve

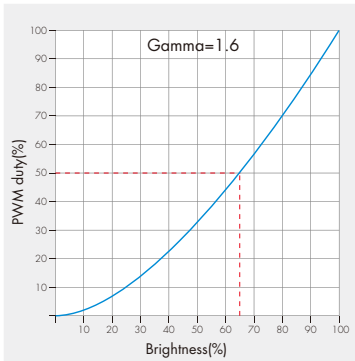

Failure analysis and troubleshooting

Fault	Cause	Solution
The light can not be turned on	<ol style="list-style-type: none"> 1. No power 2. Wrong wiring 	<ol style="list-style-type: none"> 1. Check the power supply 2. Connection test
Remote control nonresponse	<ol style="list-style-type: none"> 1. Run out of battery 2. Beyond remote control range 3. No matching 	<ol style="list-style-type: none"> 1. Replace the battery 2. Move the remote to controller closer 3. Match the remote to LED driver
Hiccup flashing	Overload	Check the power of the light
Controlled by other remote	Wrong pairing	Delete all pairing and pair with remote again
Multiple LED drivers are out of sync	Inconsistent fade on/off time	Set the same fade on/off time