

DMX512-SPI Decoder and RF Controller

Model No.: DS

Compatible with 45 kinds of chips / Digital display / Stand-alone function / Wireless remote control / Din rail

Features

- DMX512 to SPI decoder and RF controller with digital display.
- Compatible with 45 kinds of digital IC RGB or RGBW LED strips, IC type and R/G/B order can be set.
Compatible chips: TM1803, TM1804, TM1809, TM1812, UCS1903, UCS1909, UCS1912, SK6813, UCS2903, UCS2909, UCS2912, WS2811, WS2812, WS2813, WS2815, TM1829, TLS3001, TLS3002, GW6205, MBI6120, TM1814B(RGBW), SK6812(RGBW), WS2813(RGBW), WS2814(RGBW), UCS8904B(RGBW), SM16714(RGBW), LPD6803, LPD1101, D705, UCS6909, UCS6912, LPD8803, LPD8806, WS2801, WS2803, P9813, SK9822, TM1914A, GS8206, GS8208, UCS2904, SM16804, SM16825, UCS2603, UCS5603.
- DMX decode mode, stand-alone mode and RF mode selectable.
- Standard DMX512 compliant interface, set DMX decode start address by buttons.
- Under stand-alone mode, change mode, speed or brightness by buttons.
- Under RF mode, match with RF 2.4G RGB/RGBW remote control.
- 32 kinds dynamic mode, include horse-race, chase, flow, trail or gradual change style.

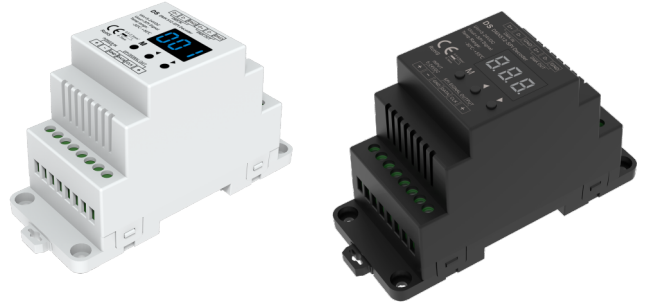

CE RoHS  RED

Technical Parameters

Input and Output		Safety and EMC		Environment	
Input voltage	5-24VDC	EMC standard (EMC)	ETSI EN 301 489-1 V2.2.3	Operation temperature	Ta: -30°C ~ +55°C
Power consumption	1W		ETSI EN 301 489-17 V3.2.4	Case temperature (Max.)	Ta: +65°C
Input signal	DMX512 + RF 2.4GHz	Safety standard	EN 62368-1:2020+A11:2020	IP rating	IP20
Output signal	SPI(TTL)	Radio Equipment(RED)	ETSI EN 300 328 V2.2.2	Package	
Dynamic mode	32	Certification	CE,EMC,RED	Size	L120 x W78 x H55mm
Control dots	170 pixels (RGB 510 CH) Max 900pixels	Warranty		Gross weight	0.129kg
		Warranty	5 years		

Mechanical Structures and Installations

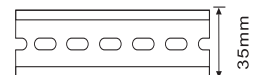
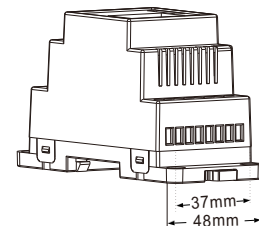
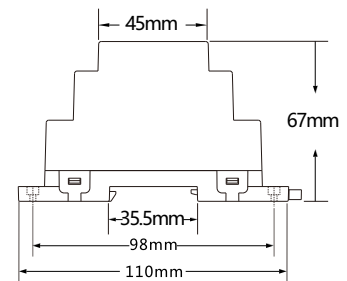
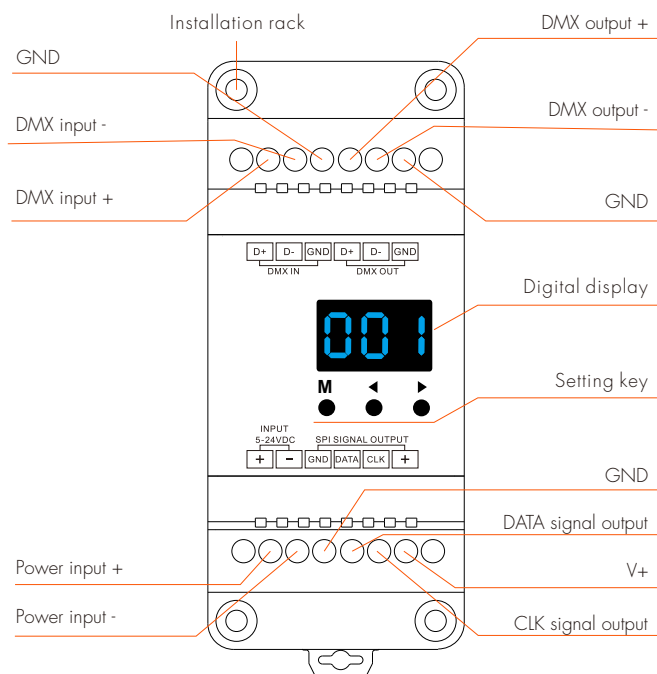

DIN Rail Mounting Size:
TS-35/7.5 or TS-35/15

Wiring Diagram

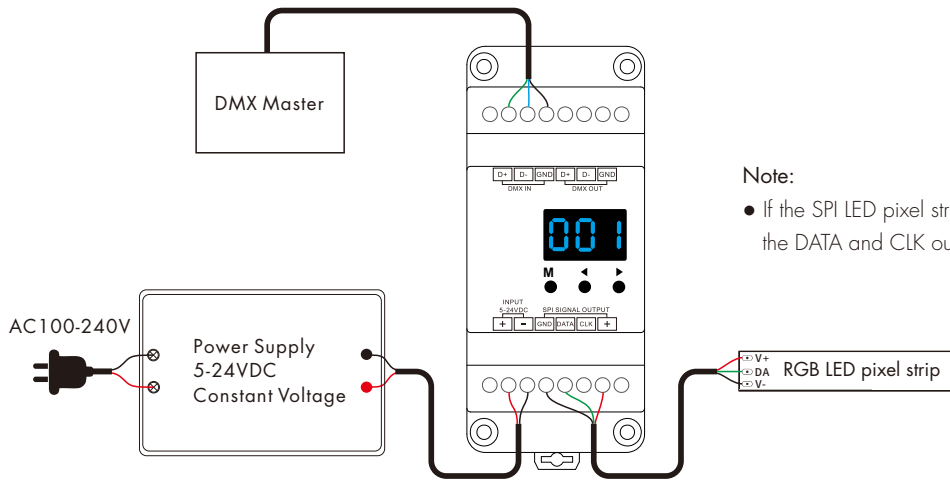

Note:

- If the SPI LED pixel strip is single-wire control, the DATA and CLK output is same, we can connect up to 2 LED strips.

Operation

IC type, RGB order and pixel length setting

- You must first assure IC type, RGB order and pixel length of the LED strip is correct.
- Long press M and ◀ key, prepare for setup IC type, RGB order, pixel length, automatic blank screen, Short press M key to switch four item.
Press ◀ or ▶ key to setup value of each item.
Long press M key for 2s, or timeout 10s, quit setting.



IC type



RGB order



pixel length



disable automatic blank screen

• IC type table:

No.	IC type	Output signal
C11	TM1803	DATA
C12	TM1809, TM1804, TM1812, UCS1903, UCS1909, UCS1912, SK6813 UCS2903, UCS2909, UCS2912, WS2811, WS2812, WS2813, WS2815	DATA
C13	TM1829	DATA
C14	TLS3001, TLS3002	DATA
C15	GW6205	DATA
C16	MBI6120	DATA
C17	TM1814B(RGBW)	DATA
C18	SK6812(RGBW), WS2813(RGBW), WS2814(RGBW)	DATA
C19	UCS8904B(RGBW)	DATA
C21	LPD6803, LPD1101, D705, UCS6909, UCS6912	DATA, CLK
C22	LPD8803, LPD8806	DATA, CLK
C23	WS2801, WS2803	DATA, CLK
C24	P9813	DATA, CLK
C25	SK9822	DATA, CLK
C31	TM1914A	DATA
C32	GS8206, GS8208	DATA
C33	UCS2904	DATA
C34	SM16804	DATA
C35	SM16825	DATA
C36	SM16714(RGBW)	DATA
C37	UCS5603	DATA
C38	UCS2603	DATA

- RGB order: 0-1 - 0-6 indicate six order (RGB, RBG, GRB, GBR, BRG, BGR).
- Pixel length: Range is 008-900.
- Automatic blank screen: enable ("bon") or disable("bof") automatic blank screen.

DMX decode mode

There are three DMX decode modes selectable.

DMX decode mode 1: the DMX data change light directly;

DMX decode mode 2: switch dynamic modes, brightness grade and speed grade via 3 DMX data.

DMX decode mode 3: the DMX data change light directly

(One data copy triple, control one pixel, for SPI type white light strip).



DMX decode mode

Long press M, ◀ and ▶ key at the same time to switch DMX decode mode (display "d-1") and DMX decode mode (display "d-2").

Long press M key for 2s, and then return to DMX address interface.

DMX decode mode 1:

- Short press M key, when display 001-512, enter DMX decode mode.
- Press ◀ or ▶ key to change DMX decode start address(001-512), long press for fast adjustment.
- Long press M key for 2s, prepare for setup decode number and multiple of pixels.
Short press M key to switch two item.
Press ◀ or ▶ key to setup value of each item.
Decode number(display "dno") : DMX decode channel number, range is 003-600(for RGB).
Multiple of pixels(display "Pno") : Each 3 DMX channel control length(for RGB), range is 001- pixel length.
Long press M key for 2s, or timeout 10s, quit setting.
- If there is a DMX signal input, will enter DMX decode mode automatically.

For example, the DMX-SPI decoder connect with RGB strip:

DMX data from DMX512 console:

DMX CH	1	2	3	4	5	6	7	8	9	10	11	12	13	14	15	16	17	18
DMX Data	255	0	0	0	255	0	0	0	255	255	255	0	0	255	255	255	0	255

DMX-SPI decoder output (start address: 001, decode channel number: 18, each 3 channel control length: 1):

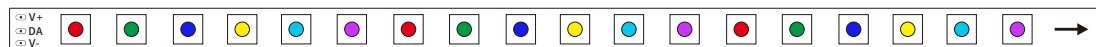

DMX-SPI decoder output (start address: 001, decode channel number: 18, each 3 channel control length: 3):

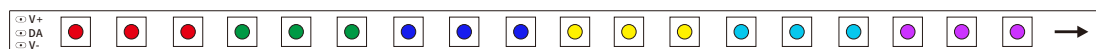

DMX decode mode 2:

- Short press M key, when display 001-512, Press ◀ or ▶ key to change DMX decode start address(001-512), long press for fast adjustment.
For example, when the DMX start address is set to 001. The address 1 of DMX console is for dynamic light type setting (32 modes), address 2 is for brightness setting (10 levels), address 3 is for speed setting (10 levels).
Long press M key for 2s, or timeout 10s, quit setting.
- Address 1 of DMX console : dynamic light mode
1: 0-8 2: 9-16 3: 17-24 4: 25-32 5: 33-40 6: 41-48 7: 49-56 8: 57-64
9: 65-72 10: 73-80 11: 81-88 12: 89-96 13: 97-104 14: 105-112 15: 113-120 16: 121-128
17: 129-136 18: 137-144 19: 145-152 20: 153-160 21: 161-168 22: 169-176 23: 177-184 24: 185-192
25: 193-200 26: 201-208 27: 209-216 28: 217-224 29: 225-232 30: 233-240 31: 241-248 32: 249-255
- Address 2 of DMX console : Brightness (when address 2<5, turn off the light)
1: 5-25 (10%) 2: 26-50 (20%) 3: 51-75(30%) 4: 76-100(40%) 5: 101-125(50%)
6: 126-150(60%) 7: 151-175(70%) 8: 176-200(80%) 9: 201-225(90%) 10: 226-255(100%)
- Address 3 of DMX console : Speed
1: 0-25(10%) 2: 26-50(20%) 3: 51-75(30%) 4: 76-100(40%) 5: 101-125(50%)
6: 126-150(60%) 7: 151-175(70%) 8: 176-200(80%) 9: 201-225(90%) 10: 226-255(100%)

DMX decode mode 3:

- Short press M key, when display 001-512, enter DMX decode mode.
- Press ◀ or ▶ key to change DMX decode start address(001-512), long press for fast adjustment.
- Long press M key for 2s, prepare for setup decode number and multiple of pixels.
Short press M key to switch two item.
Press ◀ or ▶ key to setup value of each item.
Decode number(display "dno") : DMX decode channel number, range is 001-512.
Multiple of pixels(display "Pno") : Each one DMX channel control length, range is 001- pixel length.
Long press M key for 2s, or timeout 10s, quit setting.
- If there is a DMX signal input, will enter DMX decode mode automatically.

The DMX-SPI decoder connect with white strip, one DMX data control three lamp beads:

For example, DMX data from DMX512 console:

DMX CH	1	2	3	4	5	6
DMX Data	255	192	128	64	0	255

DMX-SPI decoder output (start address: 001, decode channel number: 6, each one channel control length: 1):

Output data	255	255	255	192	192	192	128	128	128	64	64	64	0	0	0	255	255	255
-------------	-----	-----	-----	-----	-----	-----	-----	-----	-----	----	----	----	---	---	---	-----	-----	-----

DMX-SPI decoder output (start address: 001, decode channel number: 6, each one channel control length: 2):

Output data	255	255	255	255	255	255	192	192	192	192	192	192	128	128	128	128	128	128	64	64	64	64	64	64	0	0	0	0	0	0	255	255	255	255	255	255
-------------	-----	-----	-----	-----	-----	-----	-----	-----	-----	-----	-----	-----	-----	-----	-----	-----	-----	-----	----	----	----	----	----	----	---	---	---	---	---	---	-----	-----	-----	-----	-----	-----

Stand-alone mode

- Short press M key, when display P01-P32, enter stand-alone mode.
- Press ◀ or ▶ key to change dynamic mode number(P01-P32).
- Each mode can adjust speed and brightness.
 - Long press M key for 2s, prepare for setup mode speed and brightness.
 - Short press M key to switch two item.
 - Press ◀ or ▶ key to setup value of each item.
 - Mode speed: 1-10 level speed(S-1, S-9, S-F).
 - Mode brightness: 1-10 level brightness(b-1, b-9, b-F).
 - Long press M key for 2s, or timeout 10s, quit setting.
- Enter stand-alone mode only when DMX signal is disconnected or lost.

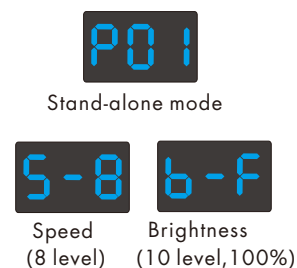

Dynamic mode list

No.	Name	No.	Name	No.	Name
P01	Red horse race white ground	P12	Blue White chase	P23	Purple float
P02	Green horse race white ground	P13	Green Cyan chase	P24	RGBW float
P03	Blue horse race white ground	P14	RGB chase	P25	Red Yellow float
P04	Yellow horse race blue ground	P15	7 color chase	P26	Green Cyan float
P05	Cyan horse race blue ground	P16	Blue meteor	P27	Blue Purple float
P06	Purple horse race blue ground	P17	Purple meteor	P28	Blue White float
P07	7 color multi horse race	P18	White meteor	P29	6 color float
P08	7 color horse race close + open	P19	7 color meteor	P30	6 color smooth sectionally
P09	7 color multi horse race close + open	P20	Red float	P31	7 color jump sectionally
P10	7 color scan close + open	P21	Green float	P32	7 color strobe sectionally
P11	7 color multi-scan close + open	P22	Blue float		

RF mode

Match: Long press M and ▶ key for 2s, display "RLS", within 5s, press on/off key of the RGB remote, display "RLO", match is successful, then use the RF remote to change mode number, adjust speed or brightness.

Delete: Long press M and ▶ key for 5s, until display "RLE", delete all matched RF remote.

Restore factory default parameter

- Long press ◀ and ▶ key, restore factory default parameter, display "RES".
- Factory default parameter: DMX decode mode 1, DMX decode start address is 1, decode number is 510, multiple of pixels 1, dynamic mode number is 1, chip type is TM1809, RGB order, pixel length is 170, disable automatic blank screen, without matched RF remote.