

Microwave Induction Dimmer & Switch

Model No.: EH-M

Motion detector/ 0-10V output/AC relay output/RF 2.4G remote/Ceiling mounting

Features

- Ceiling mounting microwave motion detectors with HF system 10.525GHz, built-in daylight sensor.
- Output 1 channel 0/1-10V signal, connect with 0/1-10V dimmable driver.
- High voltage AC input, High voltage AC relay output with zero-cross detection.
- Work as RF remote, output RF 2.4G signal, matched with RF LED controller or RF dimmable LED driver optional.
- Detection area, time delay and light threshold can be set via knob potentiometer.

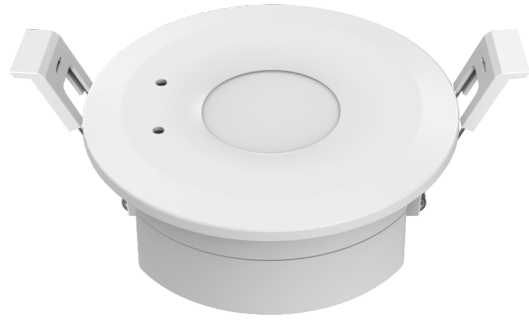

CE RoHS LVD

Technical Parameters

Working voltage	100-240VAC
Output signal	0/1-10V (Max.30mA), RF 2.4GHz
Output current	Max 4A (AC)
HF system	10.525GHz
Power consumption	<1.6W(Operation)
Detection zone	Max.(DxH) 20 x 10m
Detection sensitivity	10%/25%/50%/75%/100%
Hold time	10s/30s/90s/3min/10min/30min/+∞
Stand-by time	0s/30s/90s/3min/10min/30min/+∞
Daylight threshold	10lux/30lux/50lux/100lux/150lux/200lux/Disable
Expected light	50lux/100lux/150lux/200lux/250lux/300lux/400lux
Mounting height	10m Max.
Motion detection	0.5-3m/s
Detection angle	360° (ceiling installation)
Operation temperature	Ta: -20°C ~ +50°C
IP rating	IP20
Warranty	5 years

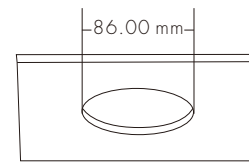

Ceiling (drill hole \varnothing 86mm)

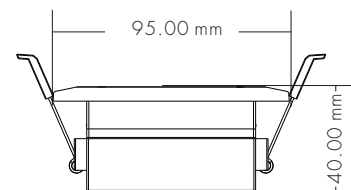
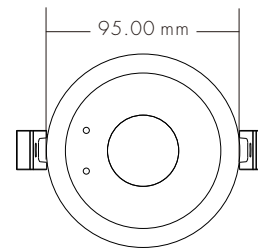

Mechanical Structures and Installations

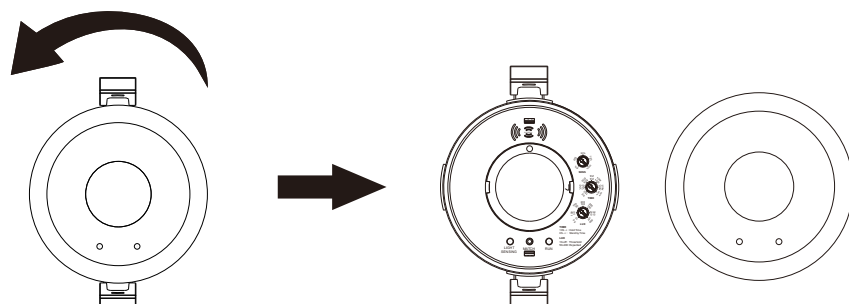
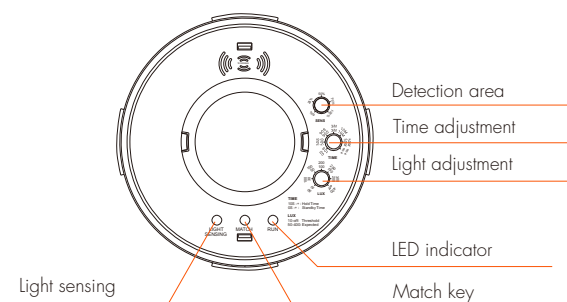
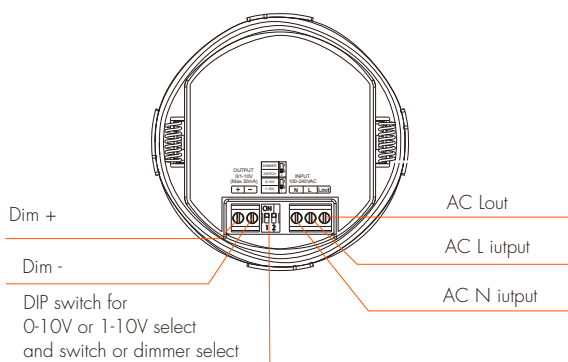

Wiring diagram

- Used as dimmer or switch, connect with 0/1-10V dimming driver (no use AC OUT)

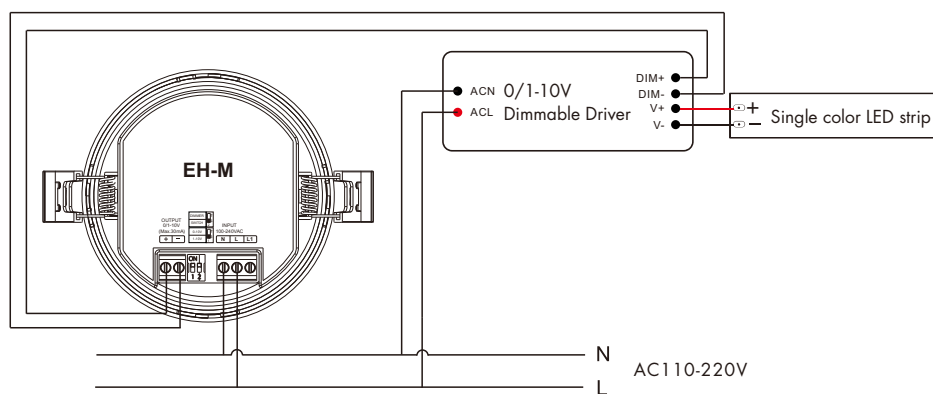

- Used as dimmer or switch, connect with 0/1-10V dimming driver (use AC OUT)

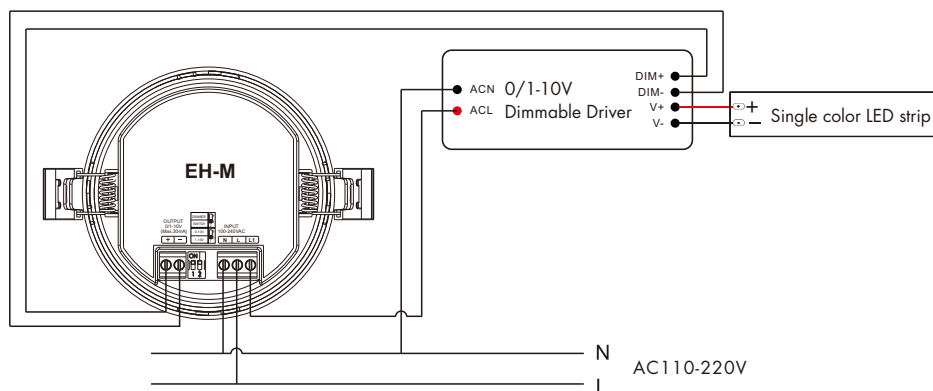

- Used as switch, connect with non-dimmable LED light (use AC OUT)

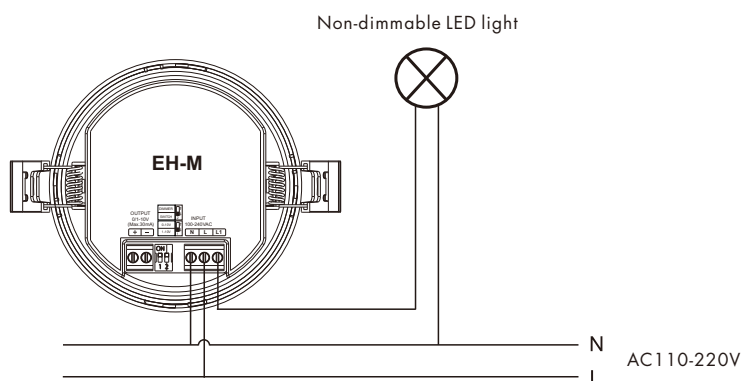

0-10V or 1-10V dimming setting

Select 0-10V dimmer or 1-10V dimmer according to dimmable LED driver.

0-10V Dimmer

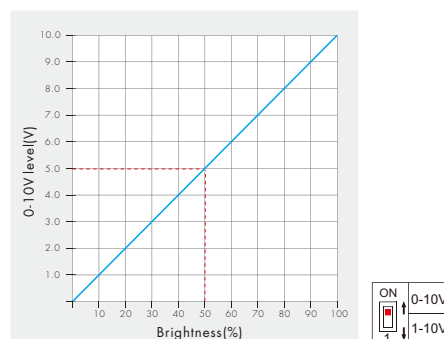

1-10V Dimmer

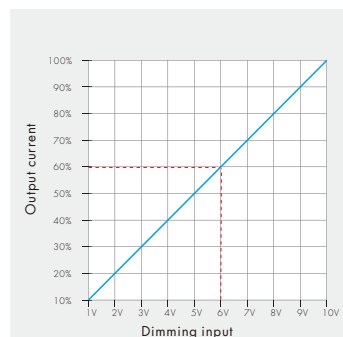
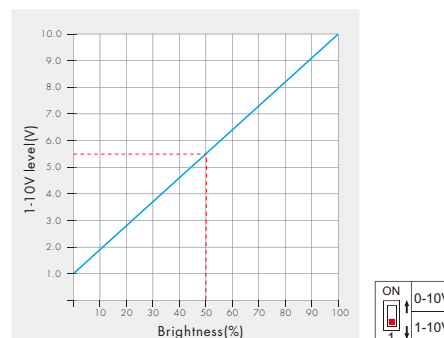

Note:

When the output channel is off, the output dimming signal is 0V or 1V. Please read the dimming section of the dimming driver manual. If the dimming characteristic curve is the same as right, you must select 1-10V dimmer and use AC OUT function, otherwise you can't turn off the lights.

Work as RF Remote (two match ways)

The microwave induction Dimmer & Switch can be matched with one or multiple RF LED controller or RF dimmable LED driver, including single color, dual color, RGB, RGBW, RGB+CCT or switch light type, turn on or turn off light by motion detection.

End user can choose the suitable match/delete ways. Two options are offered for selection:

Use the controller's Match key

Match:

Short press the match key of the controller, immediately press the match key of the microwave induction switch.

Delete:

Press and hold the match key of the controller for 5s to delete all match, The light blinks 5 times means all matched remotes were deleted.

Use Power Restart

Match:

Switch off the power of the controller, then switch on power, repeat again. Immediately short press the match key of the microwave induction switch 3 times. The light blinks 3 times means match is successful.

Delete:

Switch off the power of the controller, then switch on power, repeat again. Immediately short press the match key of the microwave induction switch 5 times. The light blinks 5 times means all matched remotes were deleted.

Detection Pattern

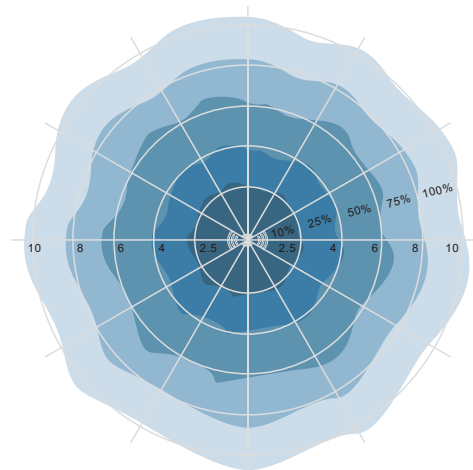

Ceiling mounting (Unit: m)
Suggested installation height: 2.5-10m

Typical application 1: used as a switch

Turns on the light upon detection of motion, and turns off after a pre-selected hold time when there is no movement.

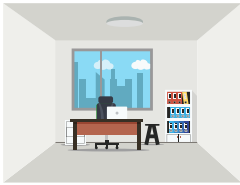

1. With sufficient ambient light, the sensor does not turn on the light.

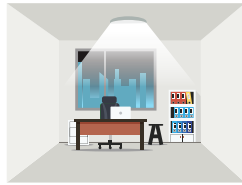

2. With insufficient ambient light, the sensor turns on the light when motion is detected.

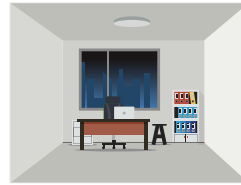

3. After hold time, the light turns off if no motion is detected.

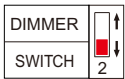

Select the DIP Switch 2 OFF to set as SWITCH type firstly, then select the combination on knob potentiometer for each specific application.



SENS

Detection area:

Detection area can be reduced by rotate knob to fit precisely each application.

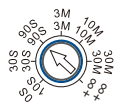

TIME

Hold time:

Refers to the time period remains light on and 100% brightness state after no motion is detected.

Stand-by time:

Refers to the time period remains light on and dim to 20% brightness state after elapse of hold time if no new motion is detected.

Holding down the match key, adjust the knob to set the stand-by time (must be 0s) firstly, then stop press the match key, adjust the knob to set the hold time.



LUX

Daylight sensor:

The sensor can be set to only allow the lamp to illuminate when below a defined ambient brightness threshold.

When set to off(Disable) mode, the daylight sensor will switch on the lamp when motion is detected regardless of ambient light level.

50lux: twilight operation. 30 lux: evening operation. 10 lux: darkness operation.

Note that daylight sensor is active only when lamp totally switches off, and the ambient lux level refers to internal light reaching the sensor.

Setting on this demonstration:

Detection area: 50% Hold time: 90S Stand-by time: 0S Daylight sensor: 50lux

Typical application 2: used as a switch with two-step dimming

Turns on the light upon detection of motion, after a pre-selected hold time, dim to 20% brightness, and turns off after a pre-selected stand-by time when there is no movement.

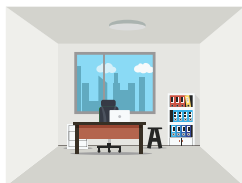

1. With sufficient ambient light, the sensor does not turn on the light.

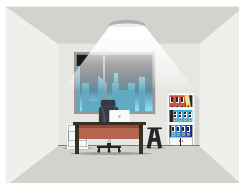

2. With insufficient ambient light, the sensor turns on the light and dim to 100% brightness when motion is detected.

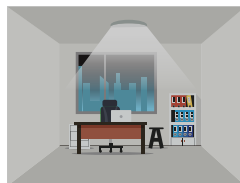

3. After elapse of hold time, the sensor dim to 20% brightness if no new motion is detected.

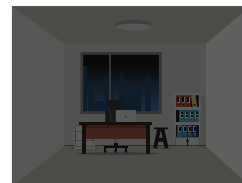

4. After elapse of stand-by time, the sensor turns off the light if no motion is detected.

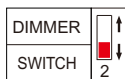

Select the DIP Switch 2 OFF to set as SWITCH type firstly, then select the combination on knob potentiometer for each specific application.



SENS

Detection area:

Detection area can be reduced by rotate knob to fit precisely each application.

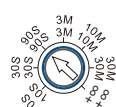

TIME

Hold time:

Refers to the time period remains light on and 100% brightness state after no motion is detected.

Stand-by time:

Refers to the time period remains light on and dim to 20% brightness state after elapse of hold time if no new motion is detected.

Holding down the match key, adjust the knob to set the stand-by time (must > 0s) firstly, then stop press the match key, adjust the knob to set the hold time (must be not +∞).

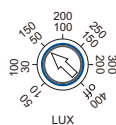

LUX

Daylight sensor:

The sensor can be set to only allow the lamp to illuminate when below a defined ambient brightness threshold.

When set to off(Disable) mode, the daylight sensor will switch on the lamp when motion is detected regardless of ambient light level.

50lux: twilight operation. 30 lux: evening operation. 10 lux: darkness operation.

Note that daylight sensor is active only when lamp totally switches off, and the ambient lux level refers to internal light reaching the sensor.

Setting on this demonstration:

Detection area: 50% Hold time & Stand-by time: 90S Daylight sensor: 50lux

Typical application 3: used as a dimmer

Turns on the light and dim up to expected brightness level upon detection of motion, and turns off after a pre-selected hold time when there is no movement.

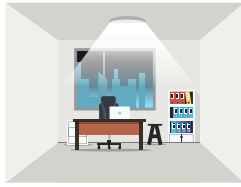

1. The sensor turns on the light and dim up to expected brightness level when motion is detected.

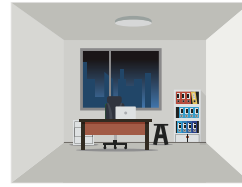

2. After hold time, the light turns off if no motion detected.

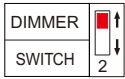

Select the DIP Switch 2 ON to set as DIMMER type firstly, then select the combination on knob potentiometer for each specific application.

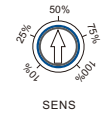

Detection area:

Detection area can be reduced by rotate knob to fit precisely each application.



Hold time:

Refers to the time period remains light on state after no motion detected. If set +∞, the lights will stay on.



Daylight sensor:

The sensor can be set to allow the lamp to illuminate to expected brightness level.

If the detected brightness is less than the expected brightness, the output will dim up to full brightness(100%).

If the detected brightness is larger than the expected brightness, the output will dim down to min brightness(1%).

Note that daylight sensor is active only when lamp switches on, and the ambient lux level refers to internal light reaching the sensor.

Setting on this demonstration:

Detection area: 50% Hold time: 90S Daylight sensor: 150lux

User recommended settings

Scenarios	Settings	Detection distance	Hold time	Daylight sensor
Passage, staircase		4-6m	10s	Twilight(50lux) / Darkness(10lux)
Balcony, corridor		4-6m	10s	Twilight(50lux) / Darkness(10lux)
Cloakroom, storeroom		2-3m	90s	Evening(30lux)
Garage		2-3m	90s	Evening(30lux)
Kitchen		3-4m	90s	Evening(30lux)
Dinning room		3-4m	3min	Evening(30lux) / Twilight(50lux)
Toilet		2-3m	3min	Daytime(>50lux) / Evening(30lux)
Meeting room		2-3m	10min	Evening(30lux)
Indoor public access		4-6m	10min	Daytime(>50lux)
Underground public access		4-6m	10min	Daytime(>50lux)

Application notice

1. The sensor is designed for indoor use only.

The raining or wind blowing may trigger the microwave sensor even if without human motion when outdoor use.

2. The sensor should be installed by a professional electrician. please turn off the power before installing, wiring and changing setting of the knob.

3. The distance between any two sensors should be at least 3m to avoid interference each other.

4. When the microwave sensor is installed in space with large reflector, for example a warehouse with metal roof, the microwave signal will be reflected and cause the lights permanent illuminated even if without motion signal.

Please reduce the detection area to solve the problems.

5. Make sure the sensor not close to or be blocked by high density materials, such as metal, glass, concrete walls etc.

The materials will reduce or block microwave signal and cause false trigger.

6. The light sensitivity threshold is in a sunny environment, no shadow and ambient light diffuse reflection.

Ambient lux level could be different in different environment, weather, climate, time-of-delay and season.

7. Make sure there are no fans, DC motor, or other vibrating objects in installation area. The movement will trigger sensor as well.