

WT-SPI RGB/RGBW SPI LED Controller

Model No.: WT-SPI

Tuya APP cloud control/Voice control/Compatible with 45 kinds IC/Customized dynamic scenario mode/Multiple music rhythms/Wireless remote control

Features

- Multi-pixel RGB/RGBW LED strip controller with SPI signal output, Tuya APP cloud control.
- Voice control, support for Amazon ECHO, Google, Tmall Genie and Xiaodu smart speakers.
- Compatible with 45 kinds of RGB or RGBW LED strips.

Factory default controllable chip types of light strips:

TM1809, TM1804, TM1812, UCS1903, UCS1909, UCS1912, SK6813, UCS2903, UCS2909, UCS2912, WS2811, WS2812, WS2813, WS2815.

Need to purchase a separate R9 remote control to set the chip type of light strips:

TM1803, TM1829, TLS3001, TLS3002, GW6205, MBI120, TM1814B(RGBW), SK6812(RGBW), WS2813(RGBW), WS2814(RGBW), UCS8904B(RGBW), LPD6803, LPD1101, D705, UCS6909, UCS6912, LPD8803, LPD8806, WS2801, WS2803, P9813, SK9822, TM1914A, GS8206, GS8208, UCS2904, SM16804, SM16825, SM16714(RGBW), UCS2603, UCS5603.

- Painted segment color mixing: full color filling, color pencil segment painting, eraser segment light off.
- Rich dynamic effects: 44 default and 10+ custom dynamic scenarios, 16 variations.
- Multiple music rhythms: 6 local music rhythms, 3 APP music rhythms.
- Match with RF 2.4G RGB remote control.



FC CE RoHS emc LVD

Technical Parameters

Input and Output		Safety and EMC		Environment	
Input voltage	5-24VDC	EMC standard (EMC)	ETSI EN 301 489-1 V2.2.3 ETSI EN 301 489-17 V3.2.4	Operation temperature	Ta: -30°C ~ +55°C
Input Current	8A	Safety standard(LVD)	EN 62368-1:2020+A11:2020	Case temperature (Max.)	Tc: +65°C
Input signal	Tuya APP + RF 2.4GHz	Certification	CE,EMC,LVD	IP rating	IP20
Output signal	SPI(TTL) x 2	Warranty		Package	
Scenario Mode	44 default and 10+ customizations	Warranty	5 years	Size	L120 x W43 x H27mm
Pixel Dots	MAX.1000			Gross weight	0.066kg

Mechanical Structures and Installations

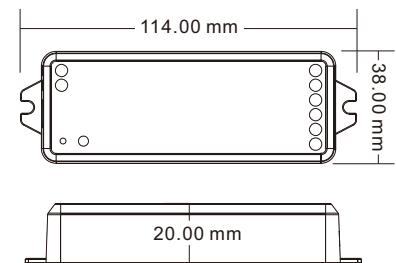
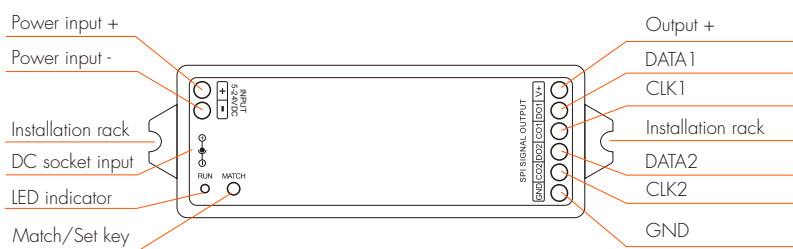

System wiring

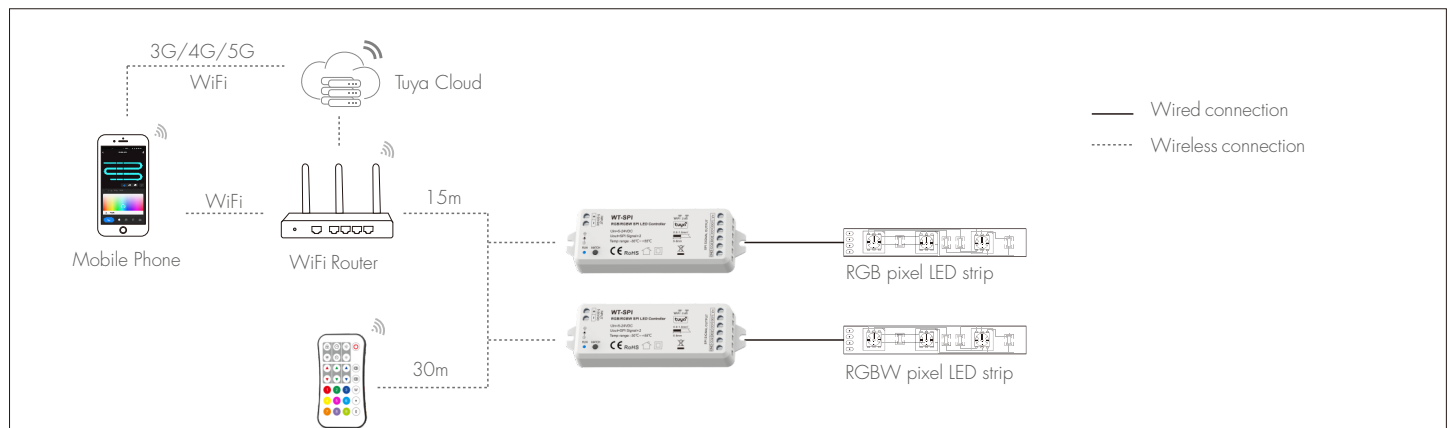

Note:

1. The above distance is measured in spacious (no obstacle) environment, Please refer to the actual test distance before installation.
2. Please check if the WiFi router net in 2.4G band, the 5G band is not available, and do not hide your router network.
3. Please keep the distance between WT-SPI devices and router close, and check the WiFi signals.
4. WiFi signal strength detection: open the main interface of social security, click enter the device interface, click "check device network" for testing.

Wiring Diagram

- WT-SPI connect with SPI spotlights (TM1803)

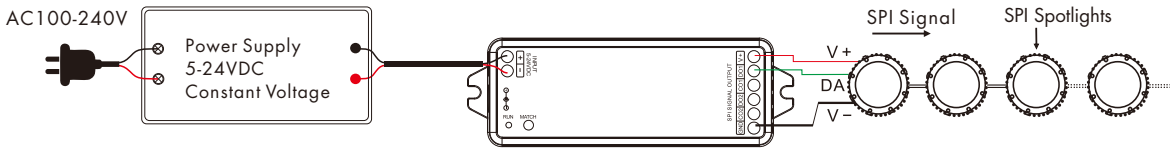

- WT-SPI connect with SPI pixel strips (LPD6803)

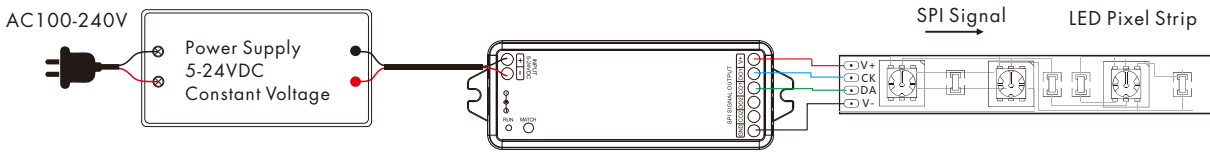

- WiFi-SPI connect with SPI digital light tube (TM1809)

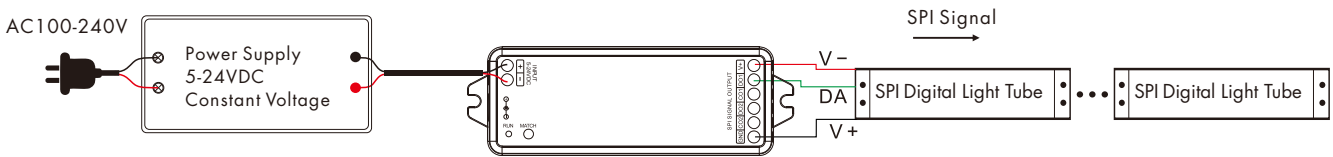

- Note:**
1. If the SPI LED strip is a single-wire control method, the DATA and CLK signal line outputs of the controller are same, and one controller can connect 4 LED strips.
 2. When the load exceeds 8A, the light strip needs to be powered by other power supplies.
Only DATA/CLK and GND cables are connected between the controller and the light strip.

Match R9 remote control

Match: Short press on the match key, immediately press on/off key of the remote. The LED indicator fast flash a few times means match is successful.
Delete: Press and hold match key for 10s to delete all match, The LED indicator fast flash a few times means all matched remotes were deleted.

Set the length, chip type and RGB order of the SPI LED strip using R9 remote control

- Set the LED strip length[number of pixels(10~1000)]: * + 3 digits + * Example:
032, set the number of pixels 32.
600, set the number of pixels 600.
1000, set the number of pixels 1000.
- Set the LED strip chip type: * + 2 digits + *
11: TM1803
12: TM1809, TM1804, TM1812, UCS1903, UCS1909, UCS1912, SK6813, UCS2903, UCS2909, UCS2912, WS2811, WS2812, WS2813, WS2815
13: TM1829
14: TLS3001, TLS3002
15: GW6205
16: MBI6120
17: TM1814B(RGBW)
18: SK6812(RGBW), WS2813(RGBW), WS2814(RGBW)
19: UCS8904B(RGBW)
21: LPD6803, LPD1101, D705, UCS6909, UCS6912
22: LPD8803, LPD8806
23: WS2801, WS2803
24: P9813
25: SK9822
31: TM1914A
32: GS8206, GS8208
33: UCS2904
34: SM16804
35: SM16825
36: SM16714(RGBW)
37: UCS5603
38: UCS2603
- Set LED strip RGB order: * + 1 digit + *
1:RGB, *2*:RBG, *3*:GRB, *4*:GBR, *5*:BRG, *6*:BGR.

Note: The factory default light strip chip type is *12*, if you need to change the chip type or RGB order, you must use the R9 remote control.

Tuya APP network connection

Push twice Match key fastly, or press and hold Match key for 2s:
clear previous network connection, enter Smart config mode, LED indicator flash fastly.

Press and hold Match key for 5s:
Clear previous network connection, enter AP config mode, LED indicator flash slowly.
If smart config failed, please try AP config.

If Tuya APP network connection succeed, the RUN LED indicator will stop flash, and in Tuya APP, you can find RGB-SPI device .

Tuya APP interface

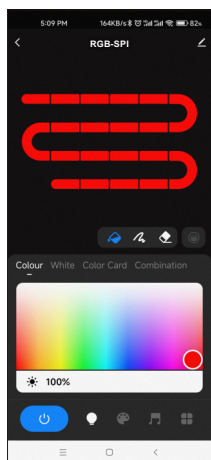

Colour:

Touch the color rectangle to adjust color and saturation.
Touch the brightness slide to adjust brightness.

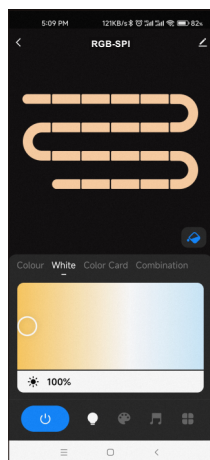

White:

Touch the color rectangle to adjust color temperature.
Touch the brightness slide to adjust brightness.

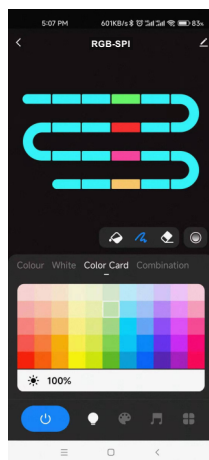

Color Card:

Touch the color card array to select many different colors.
Touch the brightness slide to adjust brightness.

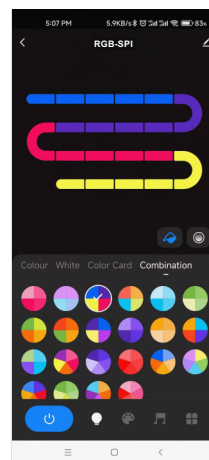

Combination:

Select a proportional distribution of multi-color circle, evenly distribute these colors on the LED strip.



Color Fill: Change the color of the full segment of the LED strip.



Color pen: change the color of a single segment of the LED strip.



Eraser: Erase the color of a single segment of the LED strip, i.e., turn off the light.



Color transition: When there are multiple colors in the LED strip, you can set to turn on or off the color gradient transition.

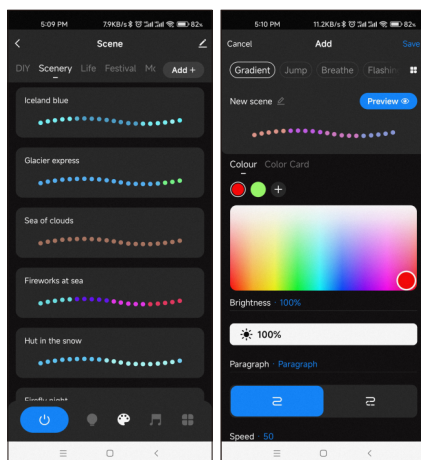

Scene interface

44 predefined scenarios and 10+ custom dynamic scenarios selectable.
The custom scenarios can select 16 types variations (fade, jump, breathe, flash, flow, rainbow, shooting star, pile-up, floating down, chasing light, floating, flashing, bouncing, shuttle, chaotic flashing, open and close), the 1-8 colors, full or segment control, forward or reverse motion direction, adjustable brightness and speed.

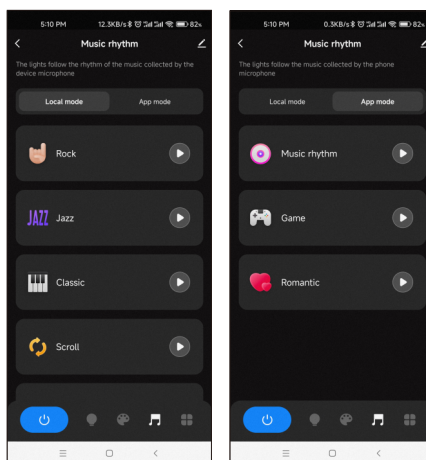

Music rhythm interface

6 local music modes (rock, jazz, classical, rolling, energy, spectrum) selectable.
3 APP modes (music rhythm, game, romance) selectable.
Adjustable sensitivity of the received sound.
The light follows the rhythm according to the music collected by the phone microphone.
Note: the controller only supports App mode.

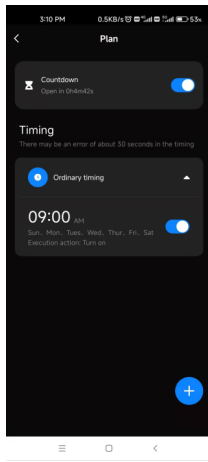
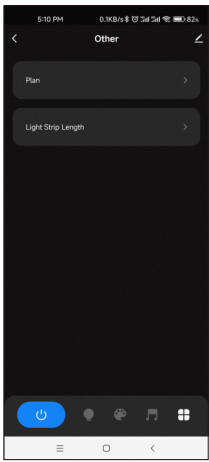

Plan interface

Countdown: Customize the countdown time (Max.24 hours) to perform the on/off action.

Timer: Customize multiple times (days of the week) to perform the on/off light action.

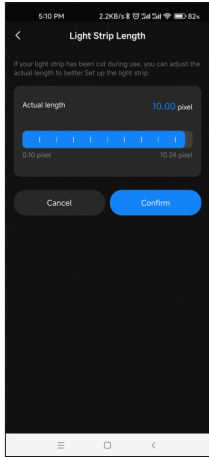

Light Strip Length interface

Strip length setting: Select the appropriate number of pixels according to the actual length of the strip, 10 -1000.

Notes.

1. In APP, a light strip is fixed with 20 segments,
 $\text{Strip length (total number of pixel points)} \div 20 \text{ segments} = \text{number of pixel points per segment}$.
2. The maximum length of the light strip is 1000 pixels, for example, a light strip of 5 meters long with 60 pixels per meter, you can set the length to 300 pixels. The whole light strip is divided into 20 segments, each segment has 15 pixels.
3. When the light strip length is less than or equal to 20 pixels, for example, 10-20, each pixel sequentially corresponds to each segment from the beginning.
4. When the light strip length is not an integer multiple of 20, the remainder of the strip will display the color of the last segment.
5. When the actual light strip length is not an integer multiple of 20, it is recommended to set the length longer and increase the value to a multiple of 20.
6. When the set of the light strip length is less than the actual length, the back part of the light strip can not be controlled.